

# Safety switch

## Series SLK – with separate actuator

Description **SLK-F-UC-55-R2-A0-L0-0**

Article number **6018119061**

**Position monitoring of guard locking**  
(not wired)

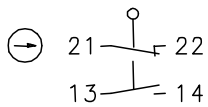

**Termination electromagnet with contact position**  
E1, E2 without current

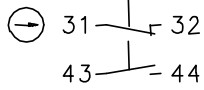
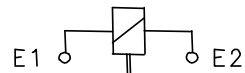

E1, E2 with current

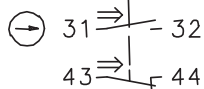
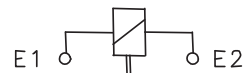

**Operating diagram**

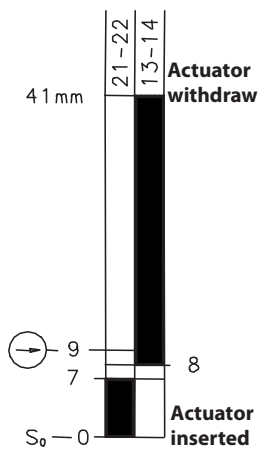

On  
 Off  
 Tolerances:  
 Actuating force:  $\pm 15\%$

The actuator is not included in the scope of delivery. It can only be purchased in conjunction with the safety switch.

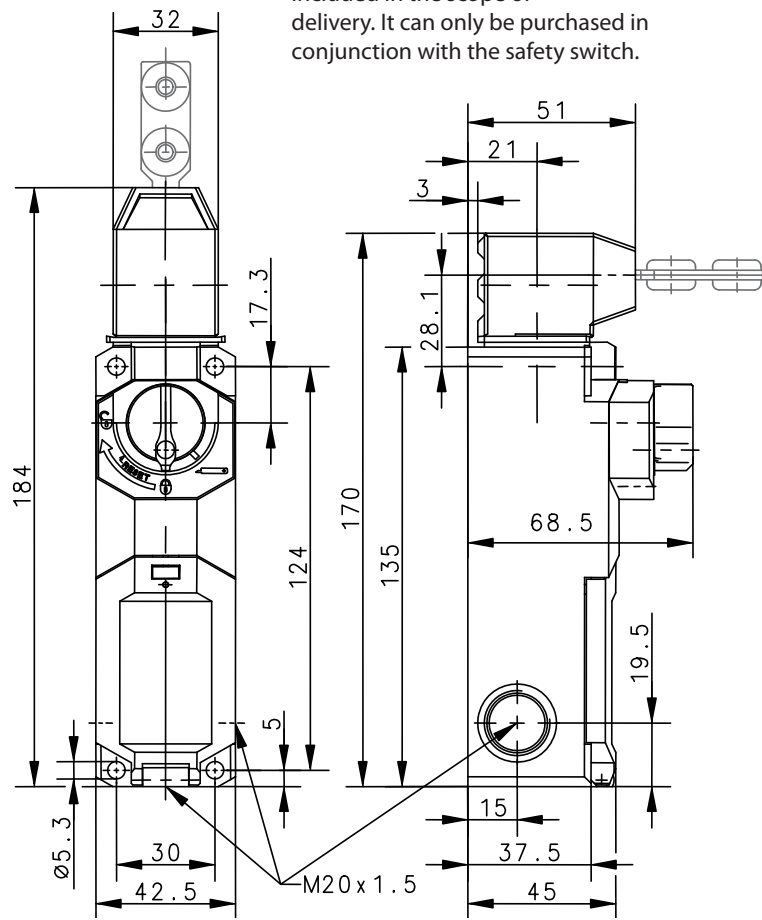

Electrical data	
Protection class	II, totally insulated
Contact elements	
Rated insulation voltage	$U_i$ 250 V
Rated impulse withstand voltage	$U_{imp}$ 2,5 kV
Conv. thermal current	$I_{the}$ 5 A
Utilization category	AC-15, $U_e / I_e$ 230 V / 2,5 A
Direct opening action	⊖ according to IEC/EN 60947-5-1, Annex K
Short-circuit protective device	4 A gG
Electro magnets	
Duty cycle	100 % ED (at E1; E2)
Temperature class	F (155 °C)
Inrush power consumption	12 VA (0,2 s)
Permanent power consumption	4,4 VA
Switch operations permanent	600 / h
Operating voltage	24 V AC / DC

Mechanical data	
Enclosure	Thermoplastic, glass fibre reinforced (UL 94-V0)
Cover	Thermoplastic, glass fibre reinforced (UL 94-V0)
Actuating head	Thermoplastic, glass fibre reinforced / Zn-GD
Actuator	Separate actuator (Steel / PA)
Minimum actuating radius	$R_{min}$ see separate actuators data sheet
Velocity for actuating	$V_{max}$ 0,5 m/s
Extraction force	≥ 27 N
Interlocking principle	Spring force
Unlocking	a) magnetic force b) emergency release from the front
Hold on force	$F_{Zh}$ ≤ 1500 N acc. to GS-ET-19
Ambient air temperature	-25 °C ... +70 °C
Contact type	2 NC, 2 NO
Switching principle	4 slow make and break contact elements
Mechanical life	1 x 10 <sup>6</sup> switching cycles (at max. 600 switch operations / h)
Assembly	4 x M5
Connection	Spring-clamp connection
Conductor cross-sections	0,5 ... 1,5 mm <sup>2</sup> flexible
Cable entrance	3 x M20 x 1,5
Weight	≈ 0,36 kg
Installation position	operator definable
Protection type	IP67 acc. to IEC/EN 60529

ID for safety engineering	
B10d	2 x 10 <sup>6</sup> cycles

Anfahrmöglichkeiten	
4 different actuating directions achievable by rotating the actuating head. Changing between horizontal and vertical actuating direction by setting the actuating head in the requested direction.	

Standards	
	VDE 0660 T100, DIN EN 60947-1, IEC 60947-1
	VDE 0660 T200, DIN EN 60947-5-1, IEC 60947-5-1
	GS-ET-19
	DIN EN ISO 13849-1

EU Conformity	
	acc. to directive 2006/42/EC (Safety-of-Machinery-Directive)

Approvals	
	DGUV
	cCSA <sub>US</sub> B300 (same polarity)
	CCC

Notes	
<p>The degree of protection (IP code) specified applies solely to a property closed cover and the use of an equivalent cable gland with adequate cable.</p> <p>The switch may not be used as a mechanical stop.</p> <p>When power is removed from the electromagnet (solenoid) the safety guard will be in locked position.</p> <p>The emergency release function is activated by rotating the rotary handle 90° clockwise. The supplied key is necessary to reset the emergency release function.</p>	